

# Jockimo™

Advanced Architectural Products

## Structural Support Methods

There are numerous options available to safely support glass flooring panels. Each project is different and in turn each project requires proper review to ensure safety. Our preferred support system is four-sided because of the high safety level involved — but this does not mean other options are not safe.

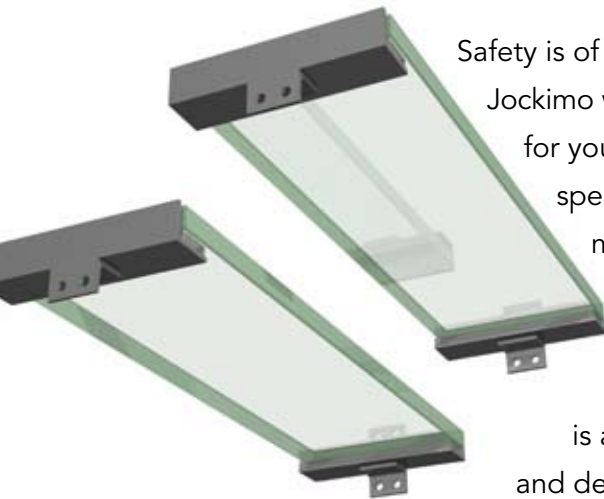

Safety is of the utmost importance and at Jockimo we engineer the glass specifically for your project with your project's specifications. Jockimo is the only manufacturer that will provide you with an engineering analysis pdf of your glass project from our structural engineer — who is a glass specialist. (Engineering and design services available.)

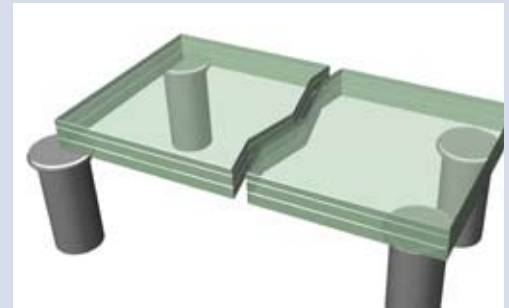
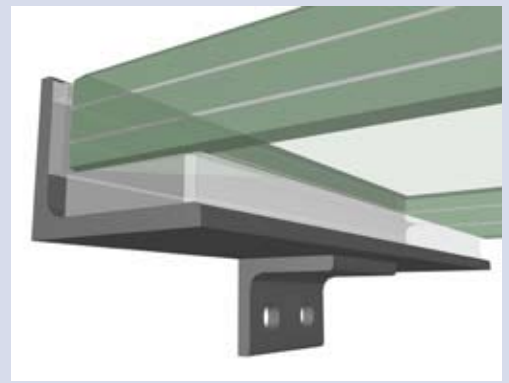

### Technical Data

**Sizes available:** Each project is manufactured per the project specifications — in turn, all panels are custom made. (Standard sizes available.)

**Thickness:** Thickness and make-up varies by project. Once we review your project we can suggest a make-up for you. (The standard make-up is 3 lites of 3/8" glass for a total thickness of approx. 1-1/4".)

**Product type:** Laminated fully tempered glass is utilized for strength. Per the new ASTM code, all glass flooring products — both panels and treads — have to be made out of a minimum of 3 pieces of glass per panel.

## Structural Support

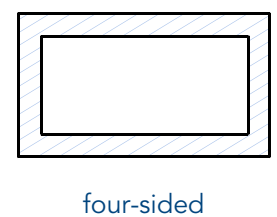
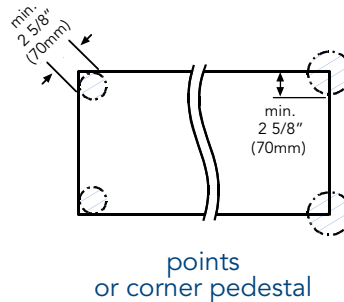
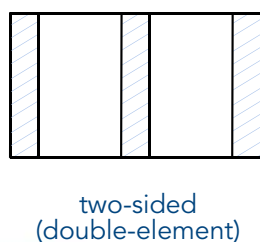
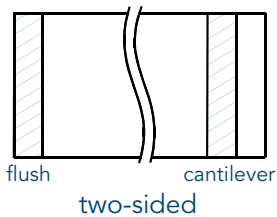

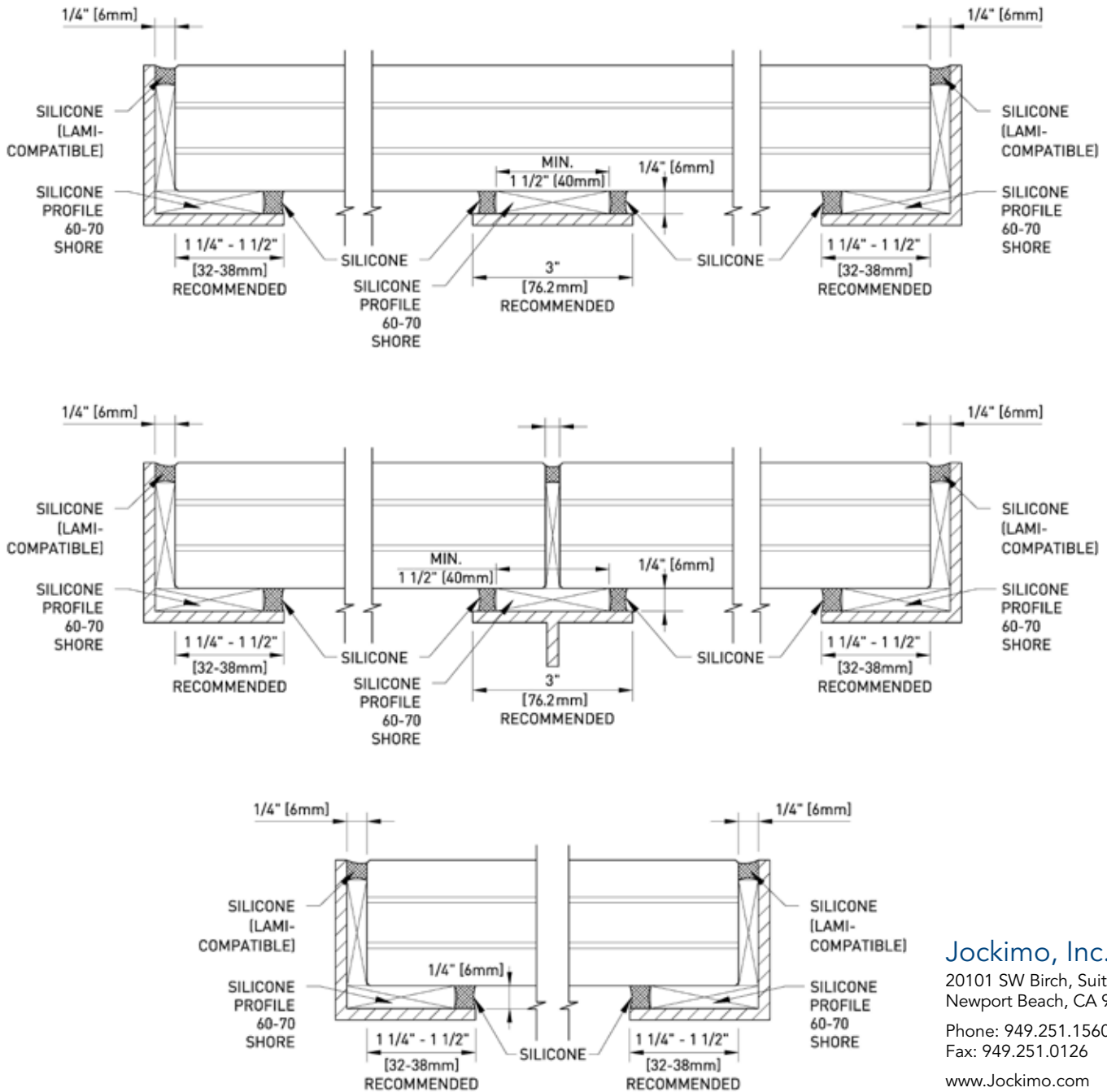

**Jockimo, Inc.**  
 20101 SW Birch, Suite #276  
 Newport Beach, CA 92660  
 Phone: 949.251.1560  
 Fax: 949.251.0126  
[www.Jockimo.com](http://www.Jockimo.com)

The silicone setting strips should be glued to the steel substructure before the glass is set. The silicone we recommend is a non-acidic clear silicone. Here is a list that we have tested as being safe and recommended:

- Dow Corning 995
- GE SCS 2800

\* Please note—using any non-recommended silicone will void the glass warranty.

The silicone setting blocks should be 60–70 shore. Various products can be used. CR Laurence has a product called PSB 250 which are 1/4" x various lengths. CR Laurence 1-800-421-6144. Other products will work as well.

There are two different ways to install setting blocks:  
 1.) Place a block every 6" – 12" around the perimeter of the support. 2.) Use a rubber/neoprene material that fully covers the support. The material can be cut to size and set in place.